



UP

20
22

UP Collection

 mobirolo

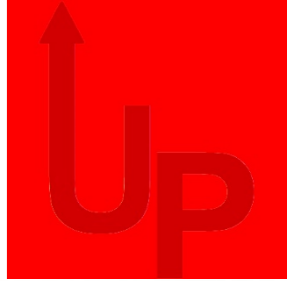

Scala a giorno con ringhiera UP-T a soffitto e colonne fissate alla trave. Trave con optional LED incorporato.



Scala in faggio spazzolato tinta tabacco (288 dec)

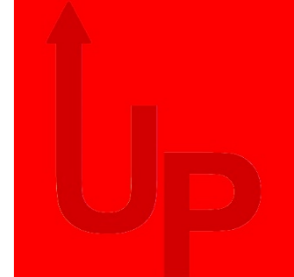

Particolare del sotto scala e ringhiera UP-T che unisce le 2 rampe contrapposte.



Scala in faggio tinta grigio basalto (381 dec)



REXAL MONO UP

Scala a giorno con ringhiera a soffitto

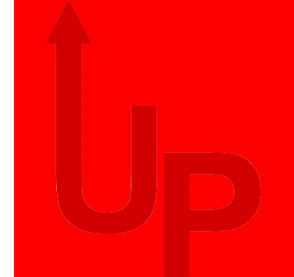

Scala a giorno in faggio tinta grigio seta (441 dec) con ringhiera UP-S fissata all'interno del foro.

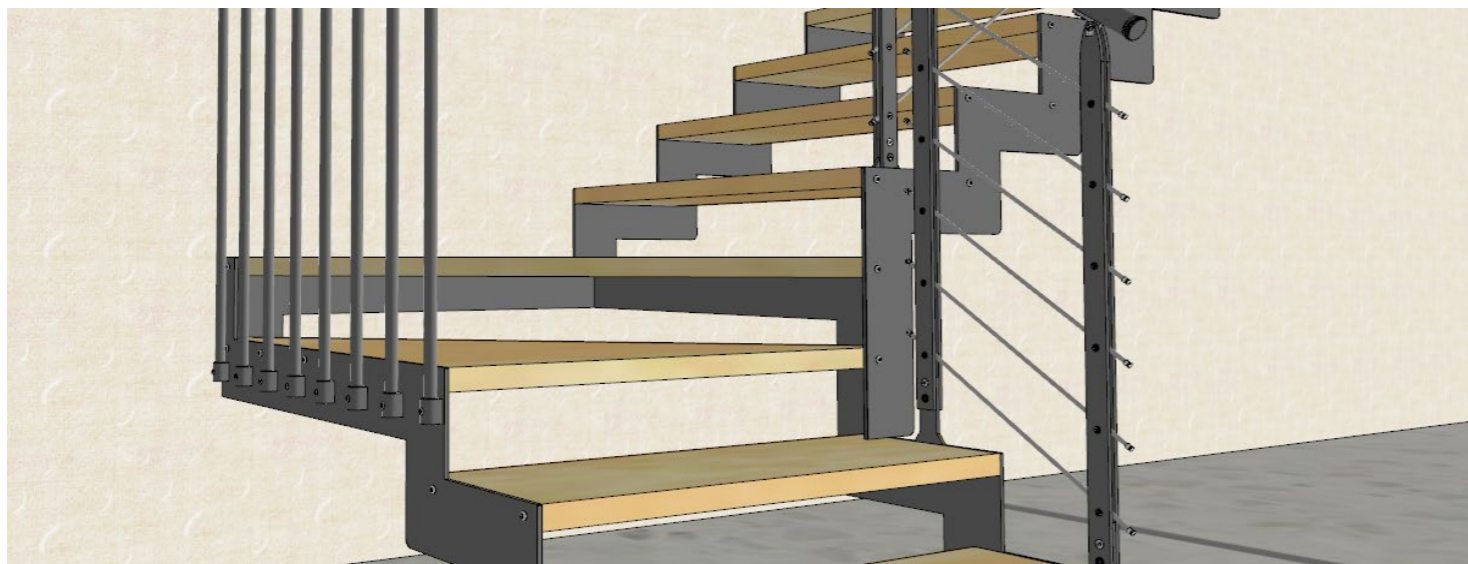
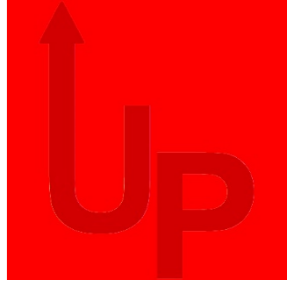

*Scala a giorno Rexal RX2V con ringhiera RX2V standard sul lato interno
e seconda ringhiera UP sul pianerottolo.*



LATERIZIO

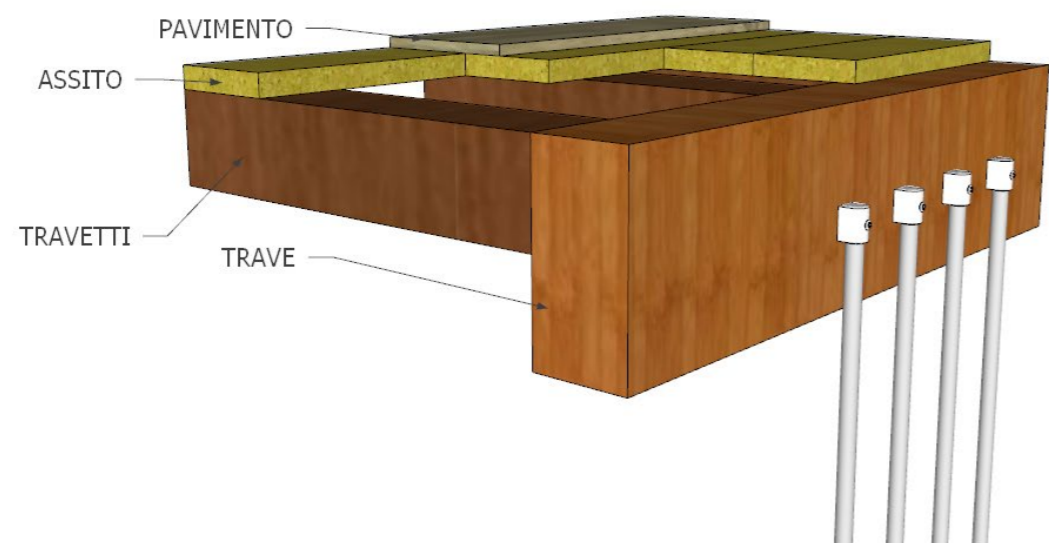

LEGNO

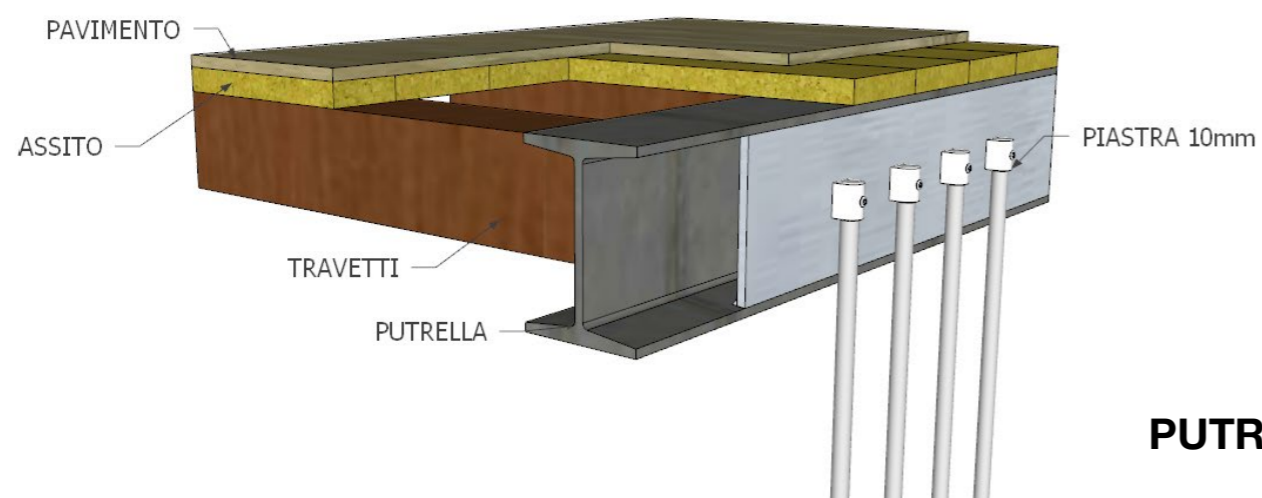

PUTRELLA

Scale a giorno con ringhiera a soffitto
TIPOLOGIE DI SOLAI E DI FISSAGGI

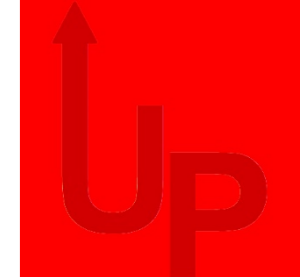

UP

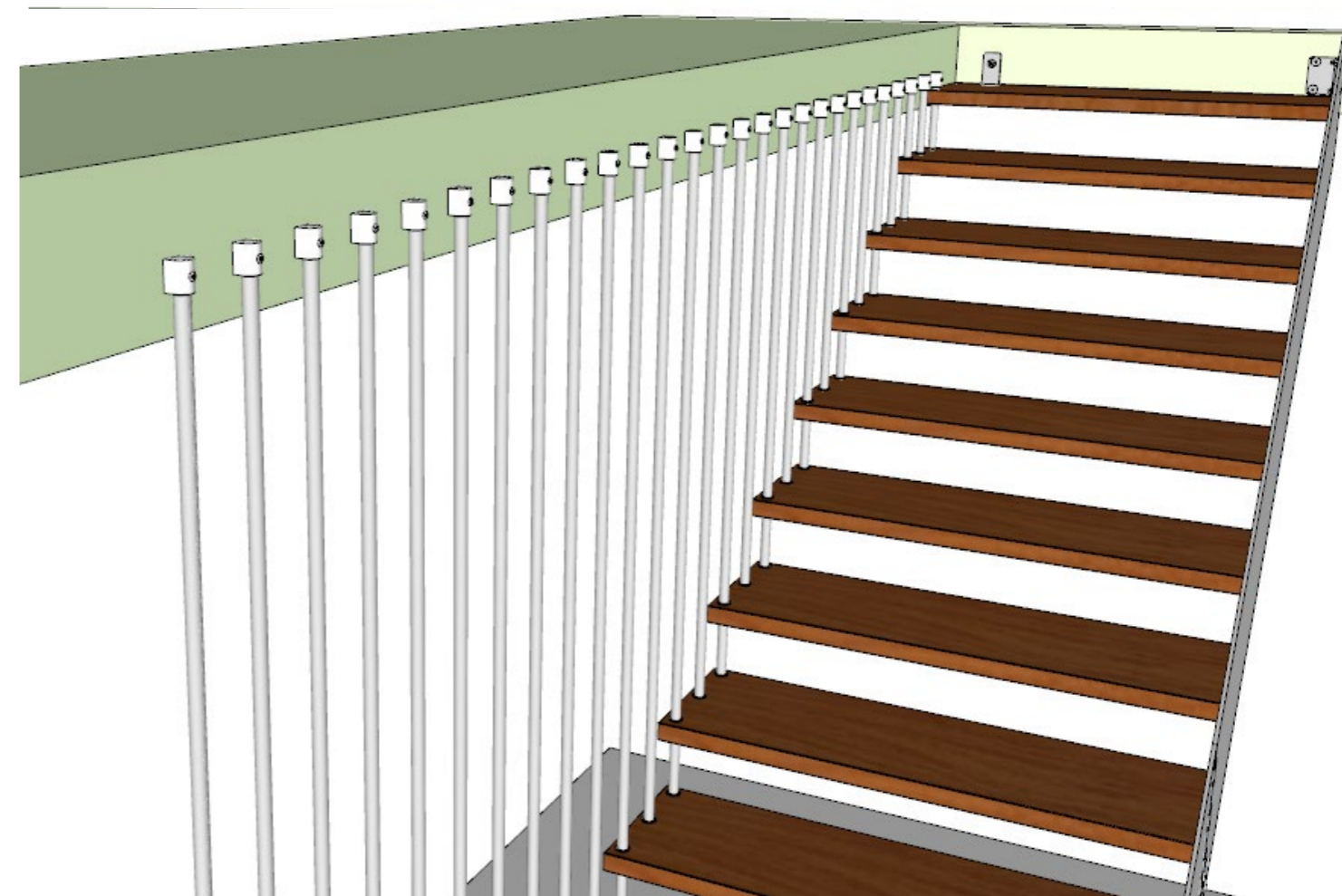

A SOLETTA INTERNO FORO

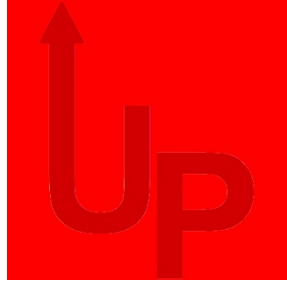

Scale a giorno con ringhiera a soffitto
TIPOLOGIE DI SOLAI E DI FISSAGGI

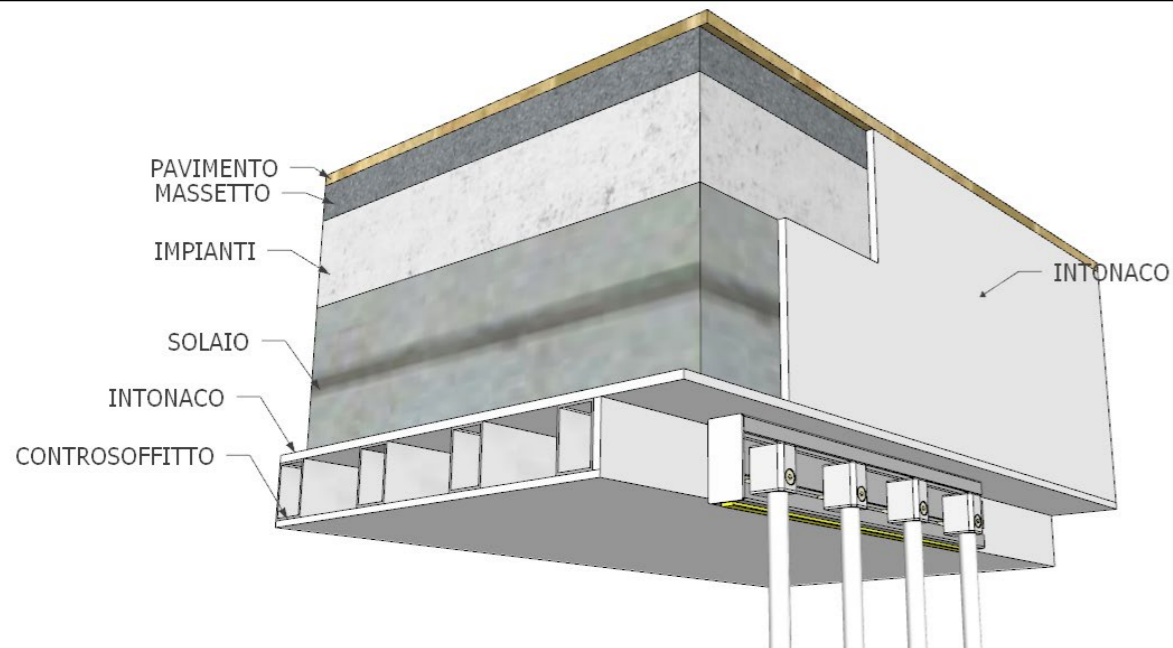

LATERIZIO

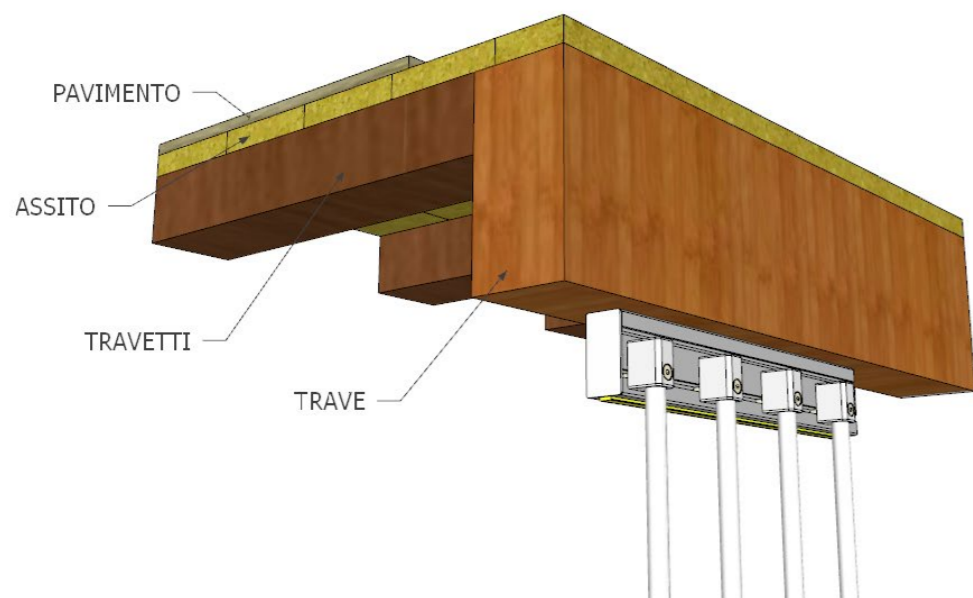

LEGNO



PUTRELLA

UP (optional fissaggio a soffitto)

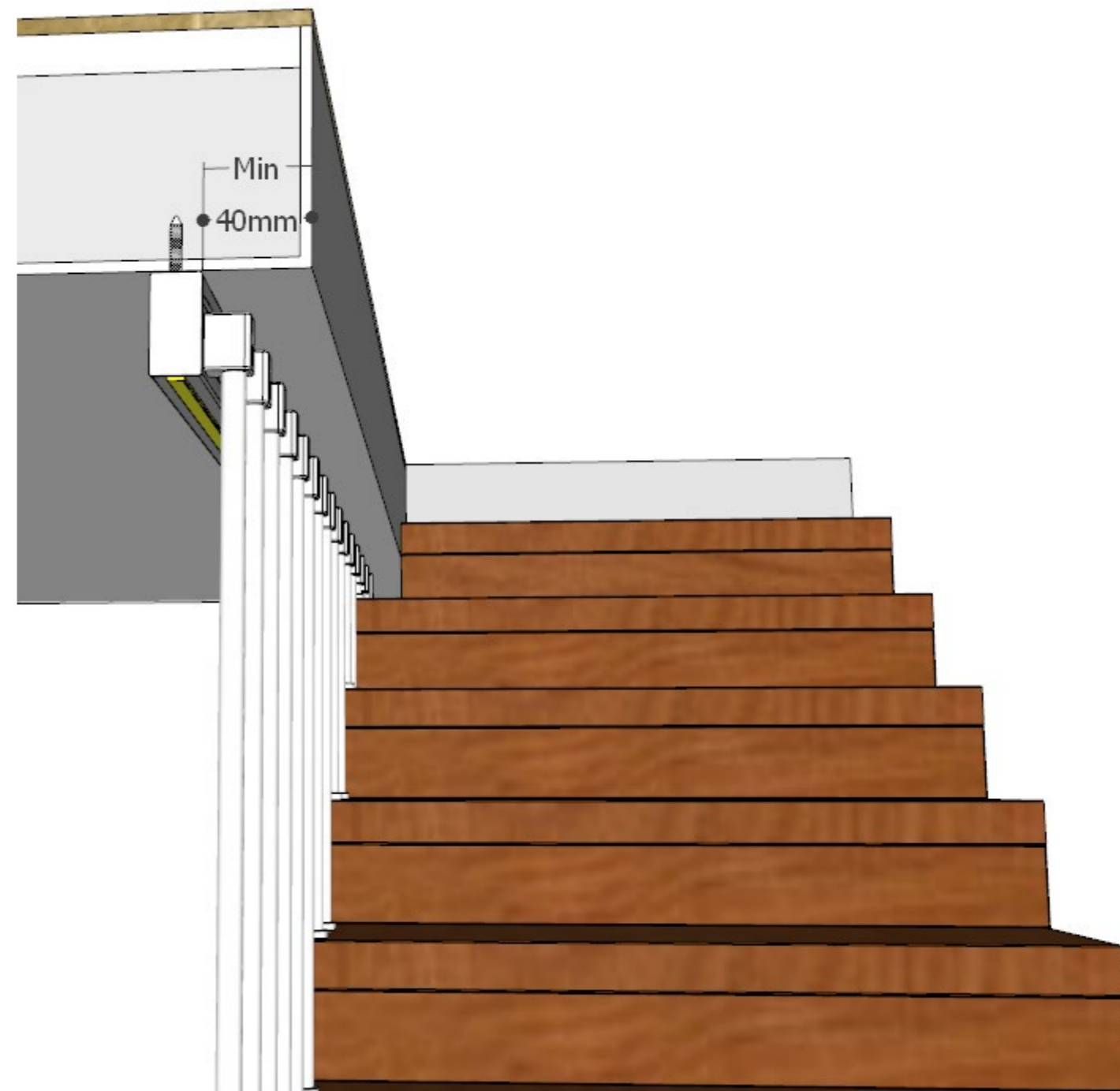

A SOFFITTO CON BINARIO ESTERNO FORO

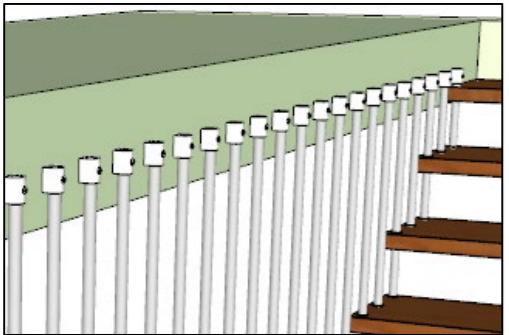
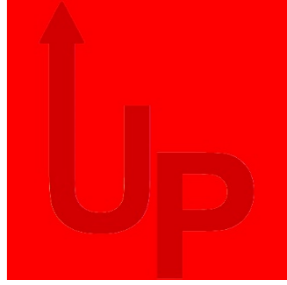

FISSAGGIO A SOLETTA INTERNO FORO

UP

La soletta deve essere perfettamente verticale (a piombo), la superficie liscia e gli angoli d'arrivo a 90°.
Per questa verifica si suggerisce di misurare la larghezza del foro in vari punti nella sua lunghezza sia nella parte alta che nella parte bassa (**L** vedi disegno).
La proiezione del foro a terra col filo a piombo, deve dare la stessa misura rilevata in quota (**L**=stessa misura in ogni punto).
Verificare gli angoli all'arrivo della scala che devono essere a 90°.

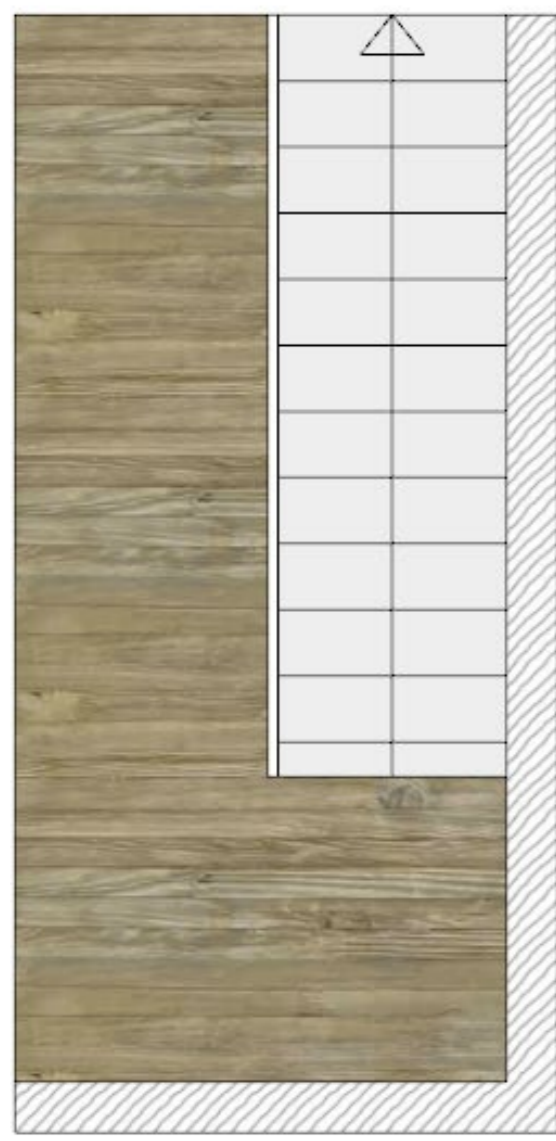

PIANTA

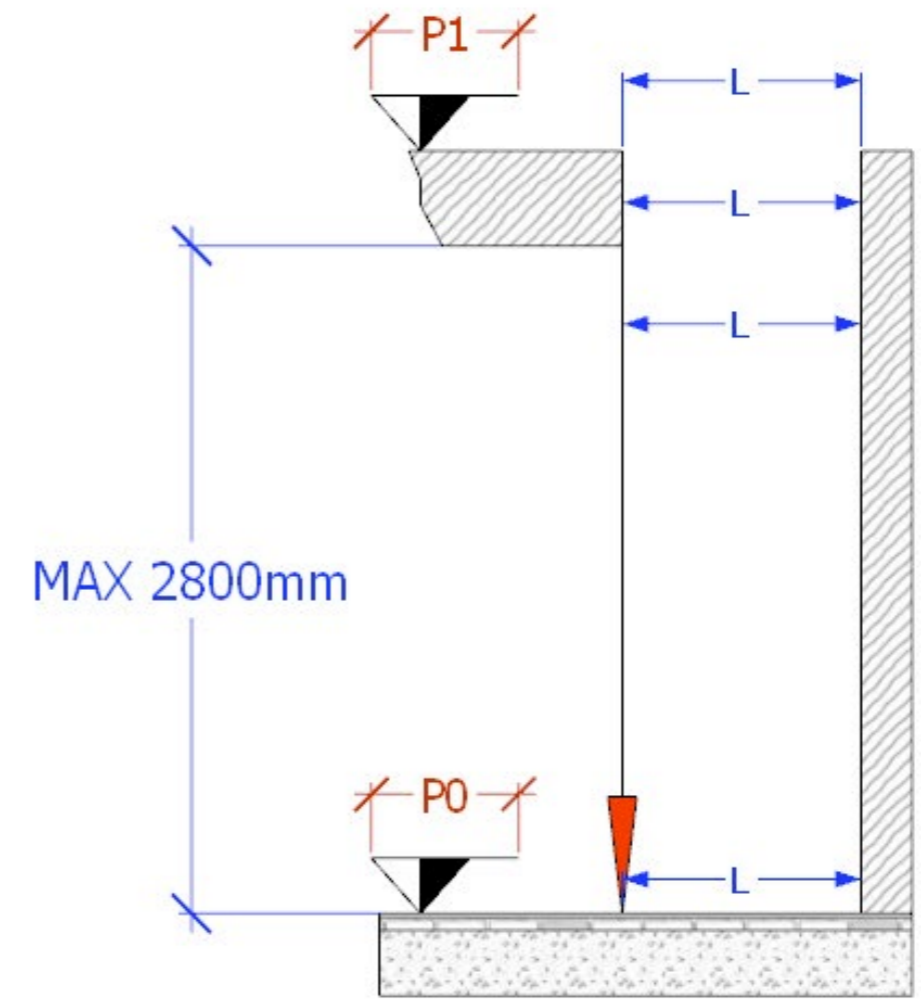
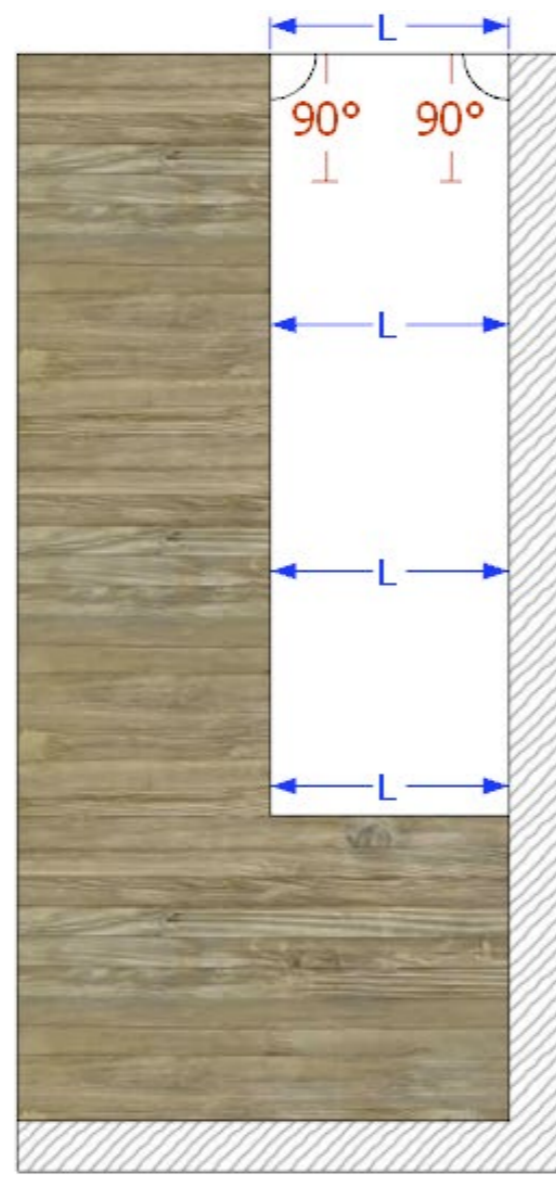

PROSPETTO

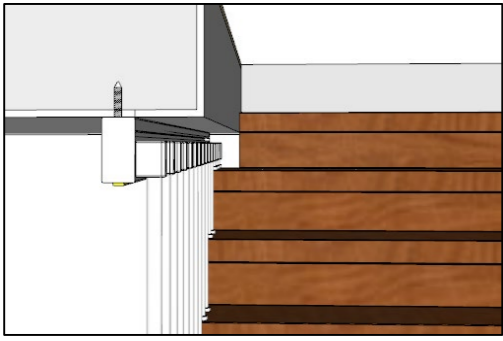
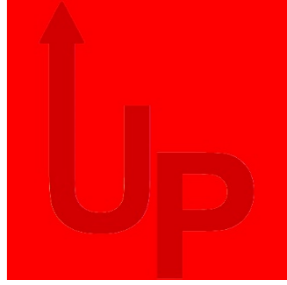

OPTIONAL FISSAGGIO A SOFFITTO

UP (optional fissaggio a soffitto)

L'optional con Binario consente di fissare i tubi dello sbarramento sotto al soffitto, mediante un profilo metallico. Questa soluzione permette una maggiore tolleranza in termini di perfezione della muratura rispetto al sistema a soletta. **La larghezza della scala è superiore alla larghezza del foro.** E' importante verificare che la larghezza del foro sia la medesima in ogni posizione (**L**=stessa misura in ogni punto). Le misure vanno rilevate nella posizione bassa della soletta (vedi disegno). Verificare gli angoli all'arrivo della scala che devono essere a 90°.



PIANTA

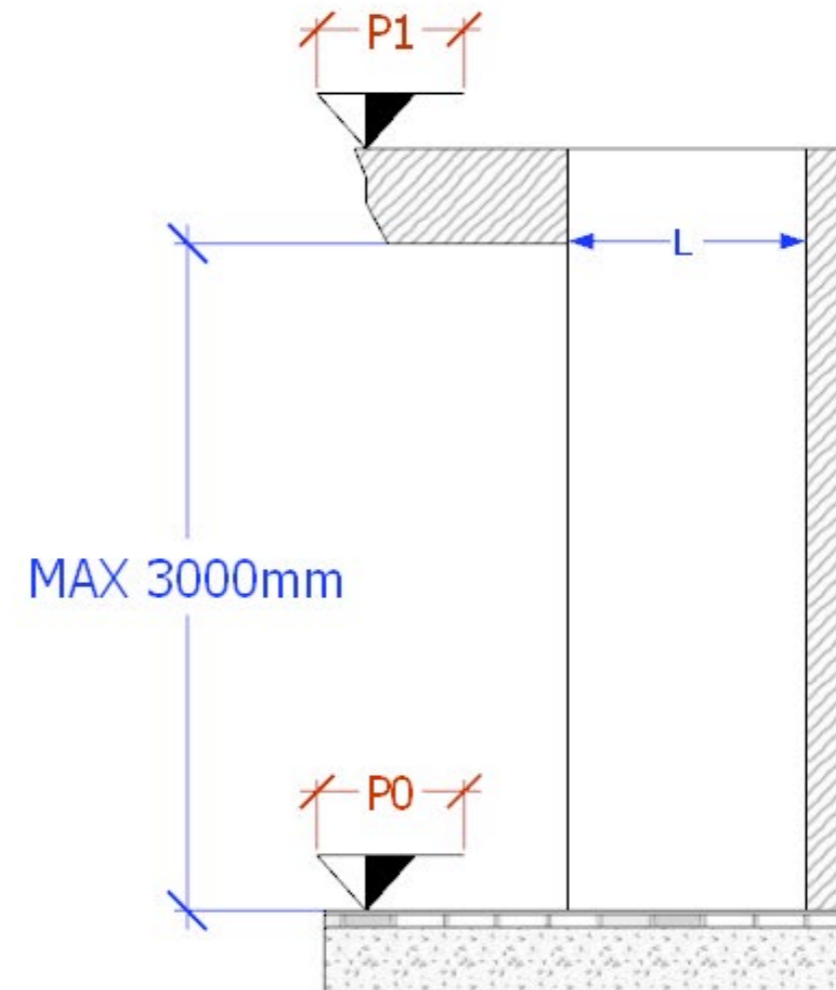

PROSPETTO



Mobirolò S.p.A. P.IVA 02620340352

Strada Cristoforo Colombo, 22/B

42046 Reggiolo (RE) Italy

Tel. +39 0522 211 811

www.mobirolò.com

e-mail: mobirolò@mobirolò.it

Export Department

Tel. +39 0522 211 836

www.mobirolò.com

e-mail: export2@mobirolò.it

