



Wastewater treatment system **one2clean**

innovative designed.



CE

As much technology as necessary, as little technology as possible.

Over the past few years, wastewater treatment systems have experienced impressive technological developments. Today, they are high-tech products equipped with sophisticated

controls and various pumps, sensors and valves. Yet this is often to the detriment of the product's reliability. A reliable wastewater disposal system no longer needs to be complicated. With

one2clean, you will be able to take responsibility for the timely disposal of your waste water, while taking care of your budget and the environment.

one2clean dispenses with the unnecessary extras, making it a reliable solution:

- 3 Only **one** tank with only **one** chamber required
- 3 Less energy consumption and less wear
- 3 No mechanical elements in the waste water
- 3 No pumps in the waste water
- 3 No electrical components in the waste water
- 3 Incredibly little sewage sludge



on sewage reservoirs



on technology



one2clean is smart and simple!



one2clean is an advanced development of the proven SBR wastewater treatment technology, with considerable advantages in terms of operating costs and safety. By purchasing the

one2clean wastewater treatment system, you are choosing GRAF quality and benefit from the experience of more than 250,000 satisfied customers.

With one2clean, wastewater disposal is safe and affordable

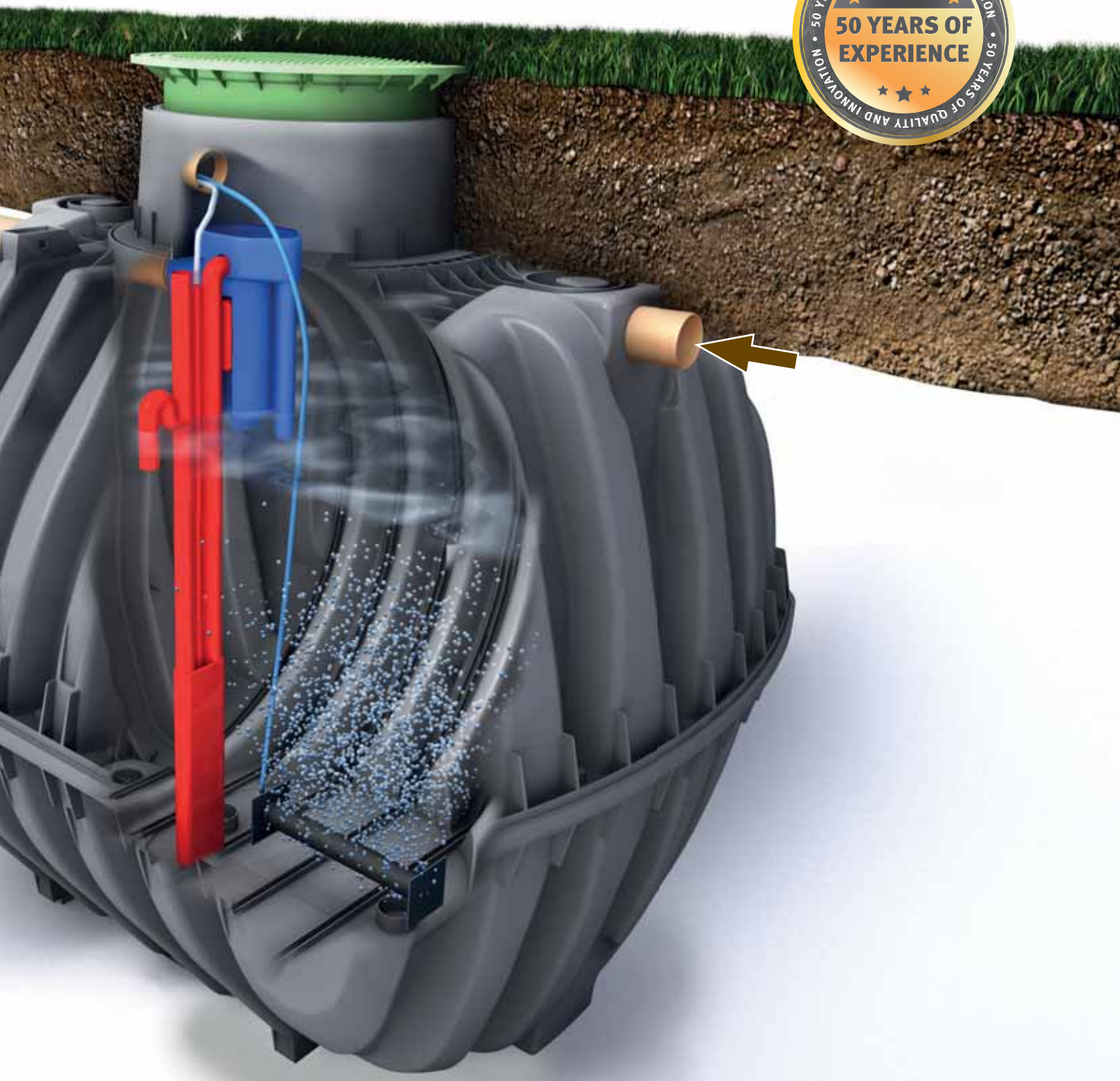

one2clean is a clean solution

one2clean only needs 3 steps to produce clear water

The wastewater treatment is carried out in one chamber in just one tank. This eliminates unnecessary pumping processes and sludge return.

one2clean is odourless

The entire waste water is immediately activated with oxygen using the unique one2clean technology. The final process of the one2clean produces an odourless, clear treated water for extraction to soakaway or waterway” *

one2clean already meets the needs of tomorrow

The one2clean wastewater treatment system can achieve sustainable discharge values with an efficiency factor of up to 99%! This offers high investment security – even if legal requirements become stricter.

* Manufacturers operating and installation instructions must be adhered to.

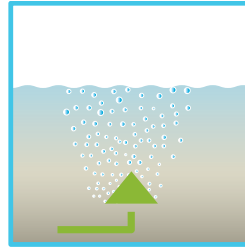

1. Wastewater treatment

The waste water arrives directly in the biological zone without the need for pumping processes. Aeration of the entire container leads to immediate waste water activation. The micro-organisms begin the biological cleaning process without delay.

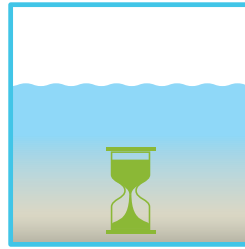

2. Settling phase

Aeration is interrupted by the control unit, the activated sludge sinks to the bottom. A clear water zone develops in the upper part of the container.

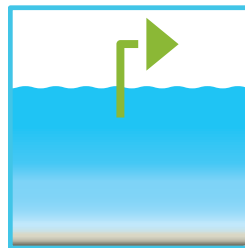

3. Clear water extraction

The treated clear water is extracted from the system and the cleaning process can begin once more.

one2clean setting-up kit

- 3 Conventional wastewater treatment systems require up to three pumping processes. one2clean only requires one pumping process, this saves energy and extends the lifetime of the air compressor – the core part of the system.
- 3 Rugged clear water lifter manufactured in one seamless piece. No connectors or screws necessary.
- 3 Simple maintenance via an integrated, self-cleaning sampling container.

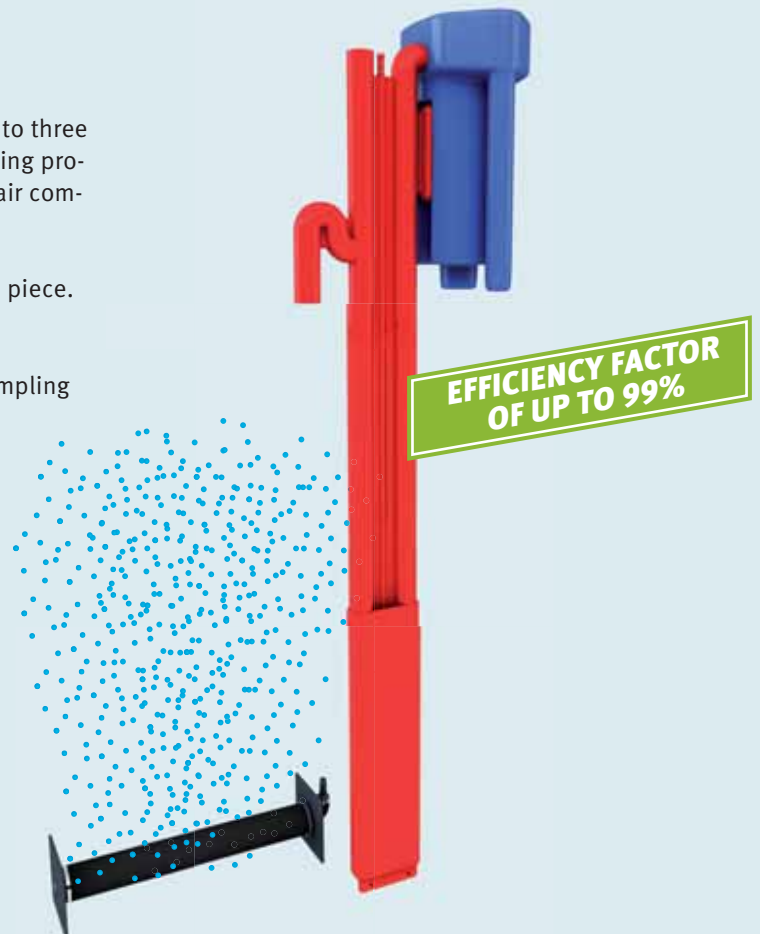

one2clean is excellent value for money



Incredibly little sewage sludge

Aeration of the entire wastewater tank

- Immediate wastewater activation
- Minimisation of the sludge
- Less sludge removal
- Cost savings

Minimum maintenance costs

- Simple construction
- High-quality components
- As much technology as necessary, as little technology as possible.
- Integrated sampling point

Minimum power consumption

- one2clean has only one pumping process, reducing energy consumption and running costs
- Economical motor valve
- Energy optimised membrane compressor

Conventional wastewater treatment systems



one2clean



Only 75 kWh per person and per year!

one2clean system control

- 3 The one2clean has a compact designed controller.
- 3 The microprocessor control system ensures simple operation and maintenance.
- 3 Ultra quiet thanks to silent diaphragm compressor.
- 3 Automatic power failure detection.

**MINIMAL
OPERATING COSTS**



one2clean offers maximum safety and reliability

Low space requirements

- Just 4 m² (5 Inhabitants)
- Less installation costs

Long warranty and lifetime

- 15-year warranty on sewage reservoirs, 3 years warranty on technology
- High-quality components
- Simple technology

Twice the buffer volume

- Dispensing with separating the reservoir into different chambers
- Therefore enough capacity for overload

Logistical advantages

The Carat S tank consists of two half shells which can be stacked on top of each other, allowing multiple tanks to be stacked on a single pallet for shipping.



Logistical advantages

GRAF TV
www.graf-water.com



Carat S septic tank

- 3 The Carat S septic tank is just as revolutionary as what goes on inside: Its injection compression moulding manufacturing process is a global first for tanks of this size. With its unique precision fit, all components and connecting cables can be mounted easily and accurately.
- 3 Patented quick connection and EPDM sealing allows the Carat S tank to be assembled without screws
- 3 Easy fitting telescopic and tilting tank cover allowing flush fitting to surrounding ground surface
- 3 Rotating tank dome facilitates connection
- 3 Only one cover required
- 3 Suitable for vehicle loading ¹
- 3 100% waterproof and corrosion-resistant
- 3 Can be mounted in groundwater



¹ When used with cast iron tank cover

one2clean – Limit values and flow parameters

Wastewater parameter	Benchmark parameters Germany	cleaning performance one2clean*	Efficiency factor
COD (chemical oxygen demand)	90 mg/l	43 mg/l	94 %
BOD ₅ (biochemical oxygen demand)	20 mg/l	7 mg/l	98 %
NH ₄ -N (ammonium nitrogen)	10 mg/l	0,5 mg/l	98 %
N _{tot} (total nitrogen)	–	7,9 mg/l	87 %
FS (filterable substances)	–	14 mg/l	96 %

*Test report: PIA2013-181B14fka

Two-reservoir system

One-reservoir system

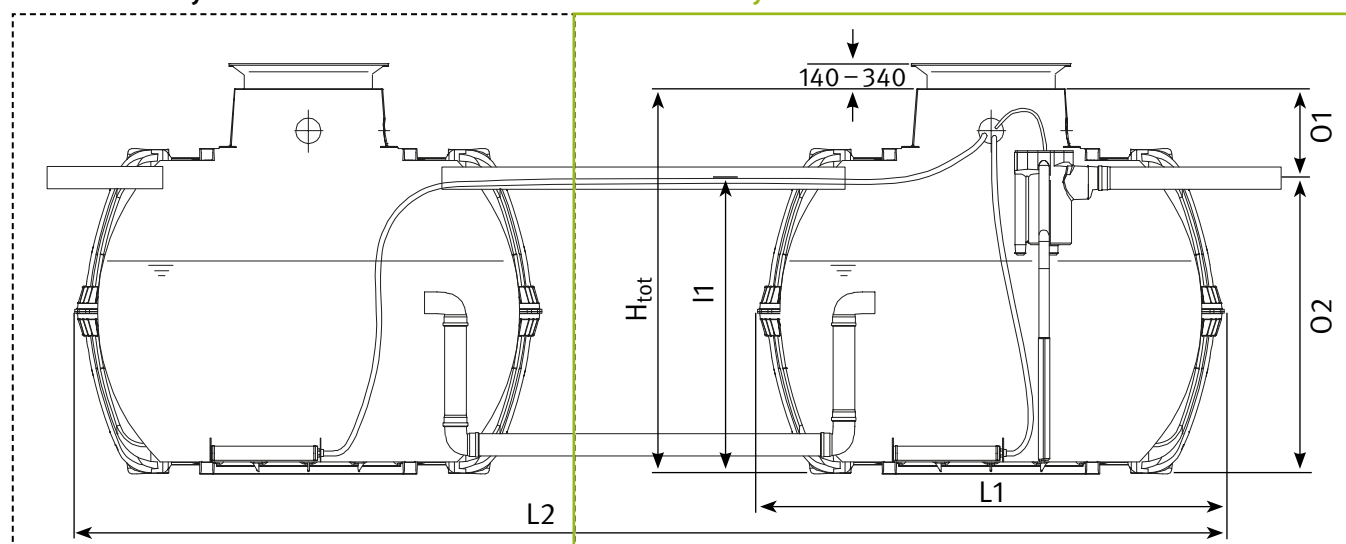

One-reservoir system

Inhabitants	Volume	max. daily flow	Length L1	Height H _{tot}	Inlet I1	Outlet O1	Outlet O2
1-3	2.700 litres (700 US gallons)	450 litres (118 US gallons)	2080 mm (81.9")	1690 mm (66.5")	1490 mm (58.6")	470 mm (18.5")	1210 mm (47.6")
4-5	3.750 litres (1.000 US gallons)	750 litres (197 US gallons)	2280 mm (89.8")	1880 mm (74.0")	1680 mm (66.1")	470 mm (18.5")	1400 mm (55.1")
6-7	4.800 litres (1.250 US gallons)	1.050 litres (277 US gallons)	2280 mm (89.8")	2110 mm (83.0")	1910 mm (75.1")	470 mm (18.5")	1630 mm (64.1")
8-9	6.500 litres (1.700 US gallons)	1.350 litres (356 US gallons)	2390 mm (94.1")	2390 mm (94.1")	2190 mm (86.2")	470 mm (18.5")	1910 mm (75.1")

Two-reservoir system

Inhabitants	Volume	max. daily flow	Length L2	Height H _{tot}	Inlet I1	Outlet O1	Outlet O2
1-7	2 x 2.700 litres (2 x 700 US gallons)	1.050 litres (277 US gallons)	4660 mm (184")	1690 mm (66.5")	1490 mm (58.6")	470 mm (18.5")	1210 mm (47.6")
8-10	2 x 3.750 litres (2 x 1.000 US gallons)	1.500 litres (395 US gallons)	5060 mm (199")	1880 mm (74.0")	1680 mm (66.1")	470 mm (18.5")	1400 mm (55.1")
11-14	2 x 4.800 litres (2 x 1.250 US gallons)	2.100 litres (554 US gallons)	5060 mm (199")	2110 mm (83.0")	1910 mm (75.1")	470 mm (18.5")	1630 mm (64.1")
15-18	2 x 6.500 litres (2 x 1.700 US gallons)	2.700 litres (712 US gallons)	5280 mm (208")	2390 mm (94.1")	2190 mm (86.2")	470 mm (18.5")	1910 mm (75.1")

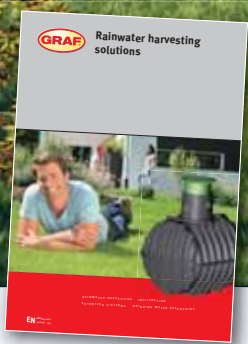

Rainwater harvesting solutions

For more information about our rainwater harvesting solutions, ask for our catalogue.



www.graf.info

RAINWATER HARVESTING



Prices:

A price list with our export conditions is available on request.

Warranty clause:

The warranty mentioned in this brochure only refers to the tank in question and not to the accessories. Within the warranty period we grant free replacement of the material. Further benefits are excluded. Pre-condition for warranty benefits are proper handling, assembly and installation according to the mounting guidelines.

N.B. Protect tanks from frost when installed above-ground! In case of groundwater installation, please contact us for further information previous to the purchase!

For all indications of measurements in this brochure we reserve a tolerance of +/- 3 %. The useful volume of the tanks may be up to 10 % lower than the tank capacity, according to the connecting option.

Technical modifications and further development of the different products are subject to change. Errors excepted.

For all our offers and conclusions of contract are only valid our General Terms and Conditions of Business dated 01/10/2012 which we will send to you on request.

STORMWATER MANAGEMENT



WASTEWATER TREATMENT SOLUTIONS



MULTIPURPOSE CONTAINERS



Otto Graf GmbH
Kunststofferzeugnisse
Carl-Zeiss-Straße 2-6
D-79331 Teningen, Germany

Phone: +49(0)76 41/5 89-0
Fax: +49(0)76 41/5 89-50
mail@graf.info
www.graf.info

© Otto Graf GmbH, Teningen, Germany
Reproduction – also in extracts –
only with written authorisation
Art.-Nr. 950386/EN